



PDT 80 Precision Drop Tester



The transport and distribution environment holds numerous opportunities for packages to experience impacts and/or drops. As a result, shock is transmitted both into, and throughout, a given package. The products within the packaging respond to both the amplitude and frequency characteristics of the shock. How the various packaging components mitigate that shock determines how much shock is transmitted into the product held within. Lansmont Drop Test Systems are used to perform pre-shipment testing in an effort to design and verify cost-effective, optimized protective packaging solutions.

PERFORMANCE SPECIFICATIONS

Maximum Package Weight:

Standard platen	177 lbs. (80.0 kg)
Extended platen option	150 lbs. (68.0 kg)

Maximum Package Size:

Standard platen	24.0 in. (61.0 cm) front to back
Extended platen option	36.0 in. (91.5 cm) front to back

Drop Height Range:

Standard baseplate	12.0 - 72.0 in. (30.5 - 183 cm)
Slotted baseplate option	1.0 - 72.0 in. (2.5 - 183 cm)
Extended platen option	18.0 - 72.0 in. (45.7 - 183 cm)

* Extended drop height available.

FLATNESS ACCURACY

Before each drop tester is shipped, its accuracy is verified to within +/- 2 degrees.

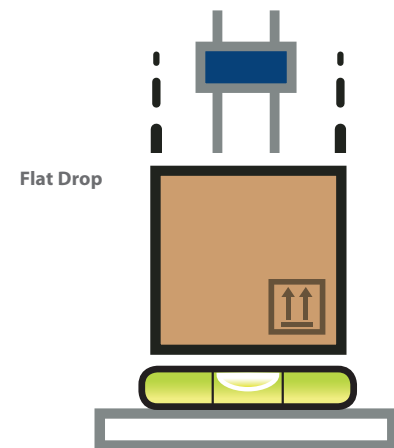



PDT 80 Precision Drop Tester



FEATURES



Handheld Controller:

The rugged handheld controller provides all necessary functionality for using Lansmont's Precision Drop Test Systems. The user can select the desired drop height via the controller and the machine will automatically move the drop platen to this height setting. No tape measure or manual adjustment is needed. All important information about the drop tester or the current settings is easily read on the LED screen on the front of the controller pendant.



Precision Cam Design:

Lansmont's precision cam and bearings design is a key machine feature for producing a flat drop event. When the drop tester is armed and fired, the drop leaf first moves

straight down faster than the package and then swings out of the way in time to clear the path for the package's free fall.



Electric Hoist:

If you are changing drop heights frequently or testing heavier packages, it pays to have a lifting mechanism to keep you from having to do all of

this work manually. The PDT 80 features an electric hoist for raising and lowering the drop leaf assembly and test package.

OPTIONS



Edge and Corner Holding Fixture:

The optional flexible structure mounts to the drop tester and holds packages in position prior to the drop event when

performing edge or corner drops.



Extended Platen:

If your package dimensions are too big for the standard platen, we offer an optional extended platen to accommodate

larger package sizes. The extended platen holds packages with a front-to-back dimension of up to 36 inches.



Slotted and Oversized Baseplates:

For customers that need to test to drop heights below 12 inches, we have a slotted baseplate

option and foundation kit that allows for drops as low as 1 inch.

Larger packages may necessitate a larger impact surface. We offer an oversized baseplate which widens the impact area from the standard 36 inches to 60 inches.



Test Partner Data Acquisition:

Lansmont's Test Partner sets the standard for data acquisition systems used for laboratory impact testing.

Test Partner is a powerful combination of software and hardware specifically tailored to capture and analyze mechanical shock, drop, and impact events. It can acquire up to sixteen channels of acceleration data simultaneously.



PDT 80 Precision Drop Tester



APPLICATIONS

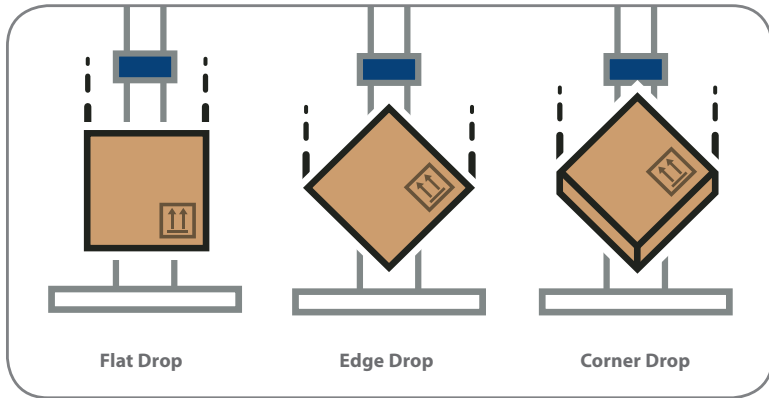

Flat Drop

Edge Drop

Corner Drop

Controlled Orientation

Test procedures and industry standards specify the requirement for controlled orientation drops, resulting in test sample impacts on predetermined faces, corners and edges. Lansmont Precision Drop testers are built in accordance with ASTM D5276 requirements.

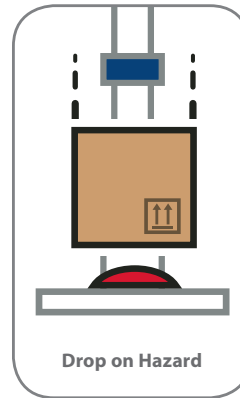

Drop on Hazard

Hazard Drops

In reality, not all items are dropped on flat, laboratory-style floors. In fact, some small parcel distribution tests require drops to occur on a predetermined hazard.

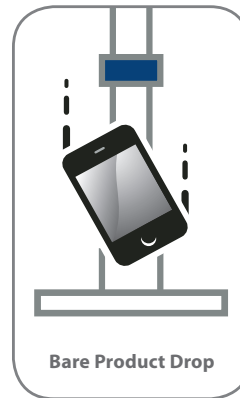

Bare Product Drop

Product Drops

Lansmont customers use drop testers to perform bare product drop testing to simulate in-use events that may occur once out of their protective packaging and in the hands of the consumer.

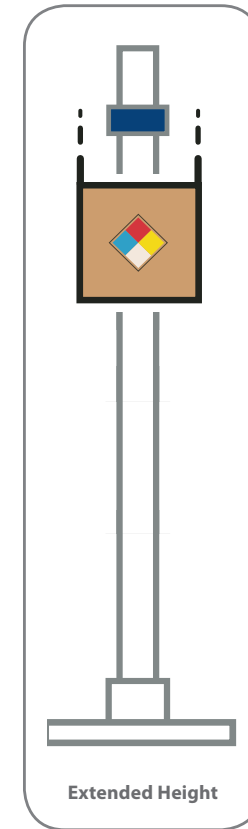

Extended Height

Extended Height

Dangerous goods packages undergo severe drop tests during certification testing. Other high performance products and packages also need to survive high energy impacts. Lansmont offers extended height drop testers to satisfy these testing applications. Custom drop height options are available to extend your machine's drop height range.

MADE TO ORDER

Not quite the equipment size or performance level that you need? If we do not already manufacture the test machine ideally suited for your company's testing applications, our engineering team can custom design a test system specific to your needs.

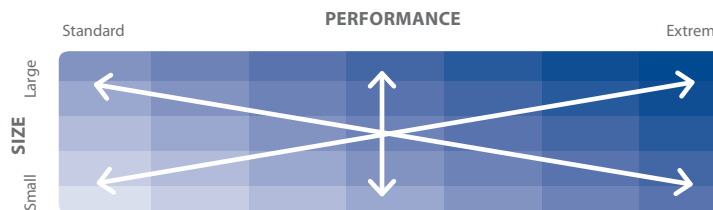



PDT 80 Precision Drop Tester



SPECIFICATIONS

UTILITIES

Power -

Standard voltages:	110 VAC - 1 phase - 60 Hz. (10 amps)	220 VAC - 1 phase - 50 Hz. (5 amps)
Optional voltages:	100 VAC - 1 phase - 50 Hz. (10 amps)	200 VAC - 1 phase - 50 Hz. (5 amps)
	100 VAC - 1 phase - 60 Hz. (10 amps)	220 VAC - 1 phase - 60 Hz. (5 amps)
		200 VAC - 1 phase - 60 Hz. (5 amps)

Plant Air -

Pressure:	40 - 60 psi (2.8 - 4.1 bar)
Flow Rate:	0.5 scfm

MACHINE DIMENSIONS (standard machine)

Height:	106 in. (269 cm)
Baseplate width:	36 in. (91 cm)
Baseplate length:	55.5 in. (141 cm)

CRATE INFORMATION (standard machine)

Height:	29 in. (74 cm)
Width:	39 in. (99 cm)
Length:	108 in. (274 cm)
Shipping Weights:	Gross Weight 850 lbs. (386 kg)
	Net Weight 520 lbs. (236 kg)

SYSTEM DRAWINGS

SIDE VIEW

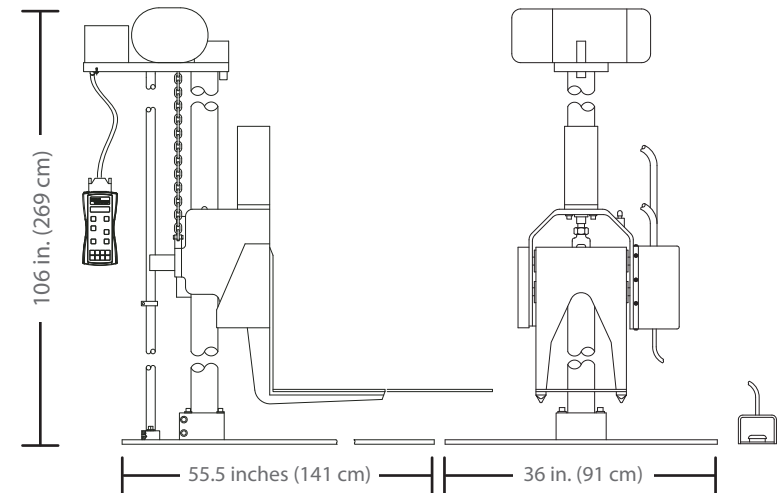

FRONT VIEW

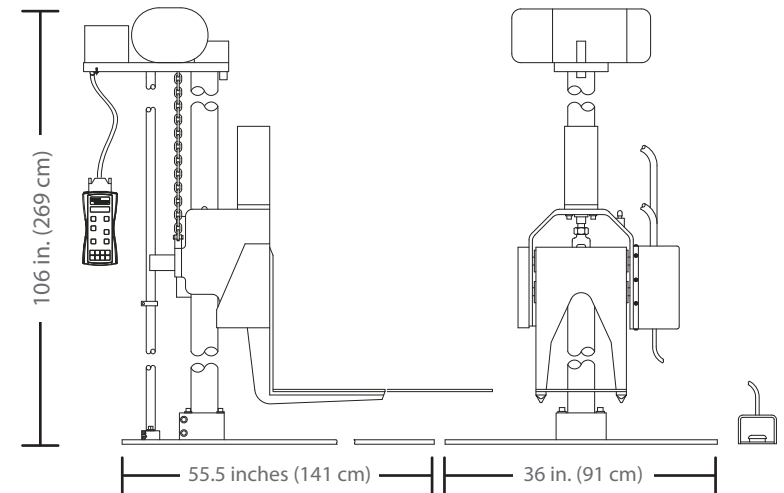

STANDARD BASEPLATE

